

**Description**

- Standard 7 x 5mm crystal oscillator in a ceramic package with a seam sealed metal lid, hermetically sealed.
- Model CFPS-72
- Model Issue number 12

**Frequency Parameters**

- Frequency 4.0MHz
- Frequency Stability  $\pm 50.00\text{ppm}$
- Operating Temperature Range  $-40.00$  to  $85.00^\circ\text{C}$
- Ageing  $\pm 3\text{ppm}$  per year max

**Electrical Parameters**

- Supply Voltage  $5.0\text{V} \pm 10\%$
- Current Draw  $20.00\text{mA}$

**Output Details**

- Output Compatibility HCMOS/TTL
- Drive Capability  $50\text{pF}$  max
- Rise and Fall Time  $10.0\text{ns}$  max
- Duty Cycle 45/55%

**Output Control**

- Standby Operation:  
Logic '1' ( $>70\%$  Vs) to pad 1 enables oscillator output.  
Logic '0' ( $<30\%$  Vs) to pad 1 disables oscillator output; the oscillator output goes to the high impedance state.  
No connection to pad 1 enables oscillator output.
- Standby Current:  $10\mu\text{A}$  max

**Noise Parameters**

- Phase Jitter RMS :  $350\text{fs}$  typical

**Environmental Parameters**

- Shock: MIL-STD-202, Method 213, Condition E.
- Vibration: MIL-STD-883, Method 2007, Condition A.

**Compliance**

- RoHS Status (2011/65/EU) Compliant
- REACH Status Compliant
- MSL Rating (JDEC-STD-033): Not Applicable

**Packaging Details**

- Pack Style: Bulk Loose in bulk pack  
Pack Size: 100
- *Alternative packing option available*

**Outline (mm)**

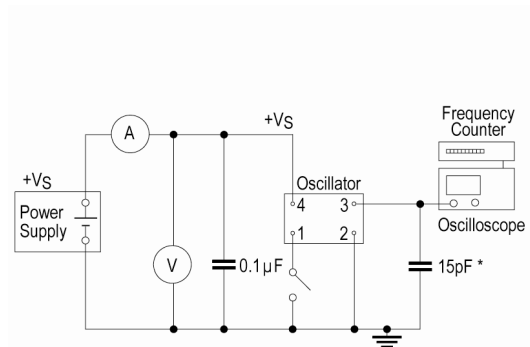
**Test Circuit**

\* Inclusive of jigging and equipment capacitance

**Sales Office Contact Details:**

UK: +44 (0)1460 270200  
Germany: 0800 1808 443

France: 0800 901 383  
USA: +1.760.318.2824

Email: [info@iqdfrequencyproducts.com](mailto:info@iqdfrequencyproducts.com)  
Web: [www.iqdfrequencyproducts.com](http://www.iqdfrequencyproducts.com)

**Wave Form**

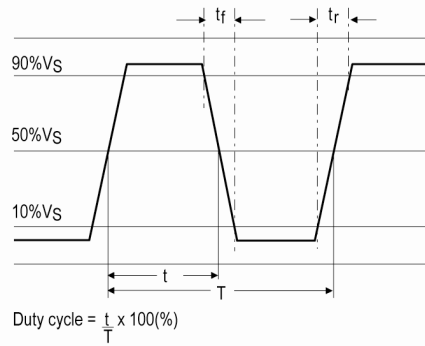

**Sales Office Contact Details:**

UK: +44 (0)1460 270200  
Germany: 0800 1808 443

France: 0800 901 383  
USA: +1.760.318.2824

Email: [info@iqdfrequencyproducts.com](mailto:info@iqdfrequencyproducts.com)  
Web: [www.iqdfrequencyproducts.com](http://www.iqdfrequencyproducts.com)