

High Voltage LED Series Chip on Board

LCo6oD



High efficacy COB LED package
well-suited for use in spotlight applications

Features & Benefits

- Chip on Board (COB) solution makes it easy to design in
- Simple assembly reduces manufacturing cost
- Low thermal resistance
- InGaN/GaN MQW LED with long time reliability

Applications

- Spotlight / Downlight
- LED Retrofit Bulbs
- Outdoor Illumination



Table of Contents

1.	Characteristics	-----	3
2.	Product Code Information	-----	5
3.	Typical Characteristics Graphs	-----	8
4.	Outline Drawing & Dimension	-----	11
5.	Reliability Test Items & Conditions	-----	12
6.	Label Structure	-----	13
7.	Packing Structure	-----	14
8.	Precautions in Handling & Use	-----	16

1. Characteristics

a) Absolute Maximum Rating

Item	Symbol	Rating	Unit	Condition
Ambient / Operating Temperature	T_A	-40 ~ +105	°C	-
Storage Temperature	T_{stg}	-40 ~ +120	°C	-
LED Junction Temperature	T_J	140	°C	-
Case Temperature	T_C	105	°C	-
Forward Current	I_F	2760	mA	-
Power Dissipation	P_D	155.1	W	-
ESD (HBM)	-	±2	kV	-
ESD (MM)	-	±0.5	kV	-

b) Electro-optical Characteristics ($I_F = 1080 \text{ mA}$, $T_A = 85 \text{ °C}$)

Item	Unit	Rank	Min.	Typ.	Max.
Forward Voltage (V_F)	V	1Z	47.8	52	56.2
Color Rendering Index (R_a)	-	3	70	-	-
		5	80	-	-
Thermal Resistance (junction to chip point)	°C/W		-	0.5	-
Beam Angle	°		-	115	-
Nominal Power	W			56.2	

c) Photo-biological Safety

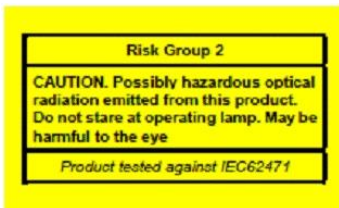
Item	Contents
	Risk Group2, Ethr(lux) - 707, Distance to reach RG1(m) - 2.16
Photo-biological Safety	

Notes:

- 1) The COB is tested in pulsed condition at rated test current (10 ms pulse width) and rated temperature ($T_J = T_C = T_A = 85 \text{ °C}$)
- 2) Samsung maintains measurement tolerance of: forward voltage = $\pm 5 \%$, CRI = ± 1
- 3) Refer to the derating curve, '3. Typical Characteristics Graph' designed within the range.

c) Luminous Flux Characteristics ($I_F = 1080 \text{ mA}$)

CRI (Ra) Min.	Nominal CCT (K)	Flux Rank	Flux @ $T_c = 85 \text{ }^\circ\text{C}$ (lm)		
			Min.	Typ.	Max.
80	2700	P9	6935	7277	-
	3000	Q3	7306	7667	-
	3500	Q5	7534	7904	-
	4000	Q6	7695	8075	-
	5000	Q7	7733	8113	-
	5700	Q7	7771	8151	-
	6500	Q6	7686	8066	-
70	3000	Q8	7895	8284	
	4000	R1	8151	8550	
	5000	R2	8275	8683	

Notes:

- 1) The COB is tested in pulsed operating condition at rated test current (10 ms pulse width) and rated temperature ($T_J = T_C = 85 \text{ }^\circ\text{C}$).
- 2) Samsung maintains measurement tolerance of: Luminous flux = $\pm 7 \%$, CRI = ± 1

2. Product Code Information

1	2	3	4	5	6	7	8	9	10	11	12	13	14	15	16	17	18
S	P	H	W	H	A	H	D	N	L	2	5	1	Z	W	3	P	0

Digit	PKG Information	Code	Specification
1 2 3	Samsung Package High Power	SPH	
4 5	Color	WH	White
6	Product Version	A	
7 8	Form Factor	HD	COB
9	Lens Type	N	No lens
10	Wattage or Model	L	LC060D
11	Internal Code	2	
12	CRI & Sorting Temperature	3	Min. 70 (85°C)
		5	Min. 80 (85°C)
13 14	Forward Voltage (V)	1Z	47.8~56.2
15	CCT (K)	W V U T R Q P	2700K 3000K 3500K 4000K 5000K 5700K 6500K
16	MacAdam Step	3	MacAdam 3-step
17 18	Luminous Flux	P9 Q3 Q5 Q6 Q7 Q8 R1 R2	Min. 6900 Min. 7300 Min. 7500 Min. 7600 Min. 7700 Min. 7800 Min. 8100 Min. 8200

a) Binning Structure ($I_F = 1080 \text{ mA}$, $T_c = 85 \text{ }^\circ\text{C}$)

CRI (Ra) Min.	Nominal CCT (K)	Product Code	V _F Rank	Chrom. Bin	Flux Rank	Flux Range (Φ _v , lm)
80	2700	SPHWWAHDNL251ZW3P9	1Z	W3	P9	6935 ~
		SPHWWAHDNL251ZW2P9		W2		
	3000	SPHWWAHDNL251ZV3Q3	1Z	V3	Q3	7306 ~
		SPHWWAHDNL251ZV2Q3		V2		
	3500	SPHWWAHDNL251ZU3Q5	1Z	U3	Q5	7534 ~
		SPHWWAHDNL251ZU2Q5		U2		
	4000	SPHWWAHDNL251ZT3Q6	1Z	T3	Q6	7695 ~
		SPHWWAHDNL251ZT2Q6		T2		
	5000	SPHWWAHDNL251ZR3Q7	1Z	R3	Q7	7733 ~
	5700	SPHWWAHDNL251ZQ3Q7	1Z	Q3	Q7	7771 ~
	6500	SPHWWAHDNL271ZP3Q6	1Z	P3	Q6	7686 ~
	70	3000	SPHWWAHDNL231ZV3Q8	1Z	V3	Q8
4000		SPHWWAHDNL231ZT3R1	1Z	T3	R1	8151 ~
5000		SPHWWAHDNL231ZR3R2	1Z	R3	R2	8275 ~

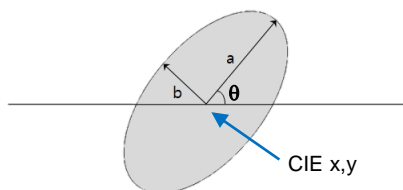
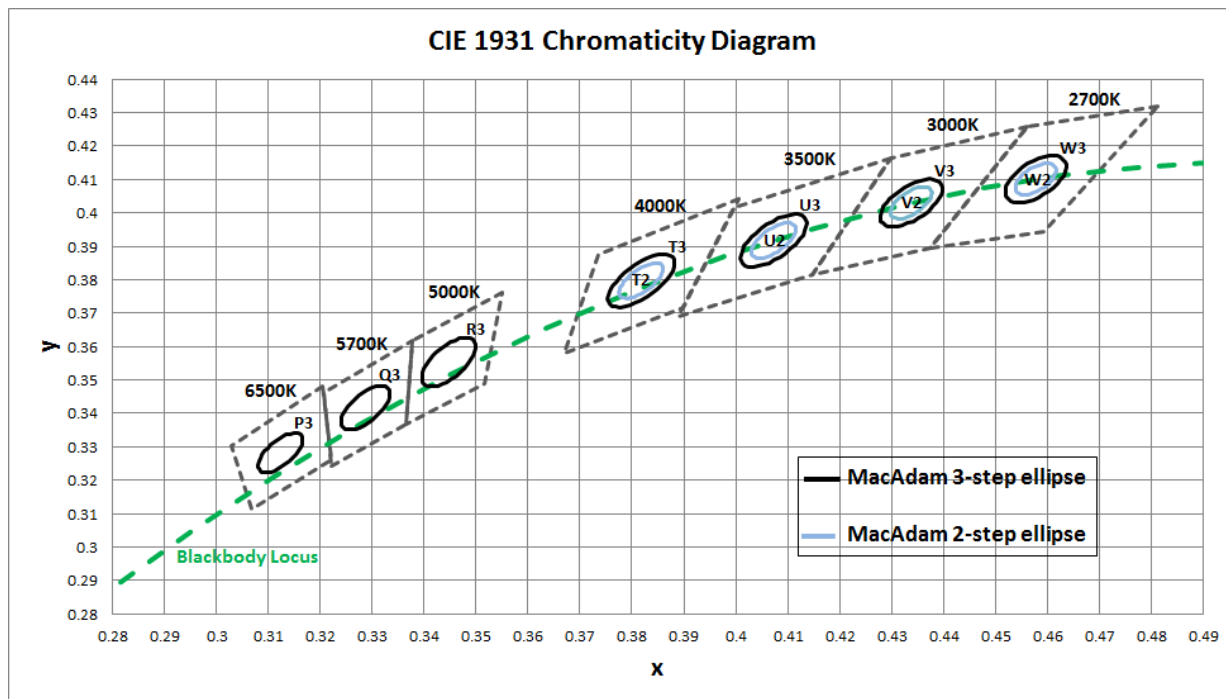
b) Chromaticity Region & Coordinates ($I_F = 1080 \text{ mA}$, $T_J = 85 \text{ }^\circ\text{C}$)

MacAdam Ellipse (W2, W3)					
Step	CIE x	CIE y	θ	a	b
2-step	0.4578	0.4101	53.70	0.0054	0.0028
3-step	0.4578	0.4101	53.70	0.0081	0.0042

MacAdam Ellipse (V2, V3)					
Step	CIE x	CIE y	θ	a	b
2-step	0.4338	0.403	53.22	0.0056	0.0027
3-step	0.4338	0.4030	53.22	0.0083	0.0041

MacAdam Ellipse (U2, U3)					
Step	CIE x	CIE y	θ	a	b
2-step	0.4073	0.3917	54.00	0.0062	0.0028
3-step	0.4073	0.3917	54.00	0.0093	0.0041

MacAdam Ellipse (T2, T3)					
Step	CIE x	CIE y	θ	a	b
2-step	0.3818	0.3797	53.72	0.0063	0.0027
3-step	0.3818	0.3797	53.72	0.0094	0.0040

MacAdam Ellipse (R3)					
Step	CIE x	CIE y	θ	a	b
3-step	0.3447	0.3553	59.62	0.0082	0.0035

MacAdam Ellipse (Q3)					
Step	CIE x	CIE y	θ	a	b
3-step	0.3287	0.3417	59.0950	0.0075	0.0032

MacAdam Ellipse (P3)					
Step	CIE x	CIE y	θ	a	b
3-step	0.3123	0.3282	58.5700	0.0067	0.0029

Note:

Samsung maintains measurement tolerance of: $C_x, C_y = \pm 0.005$

3. Typical Characteristics Graphs

a) Spectrum Distribution ($I_f = 1080 \text{ mA}$, $T_J = 85 \text{ }^\circ\text{C}$)

CCT: 2700 K (80 CRI)

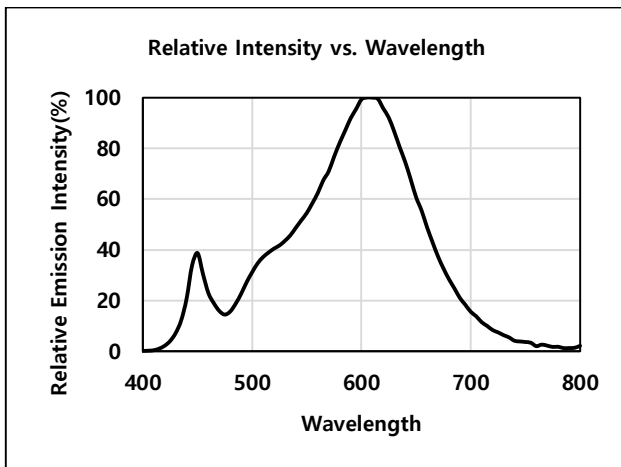

CCT: 3000 K (80 CRI)

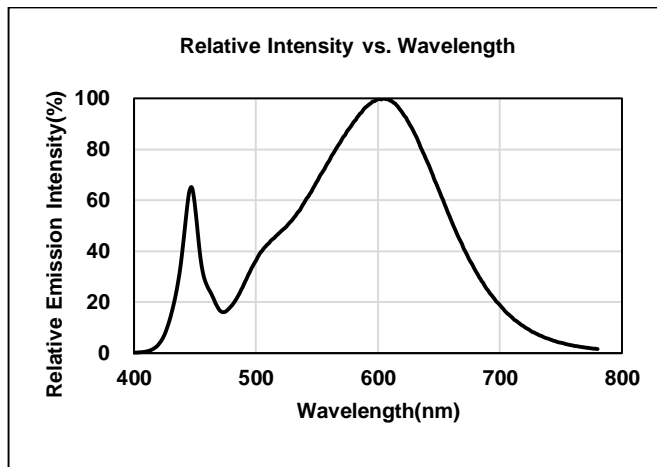

CCT: 3500 K (80 CRI)

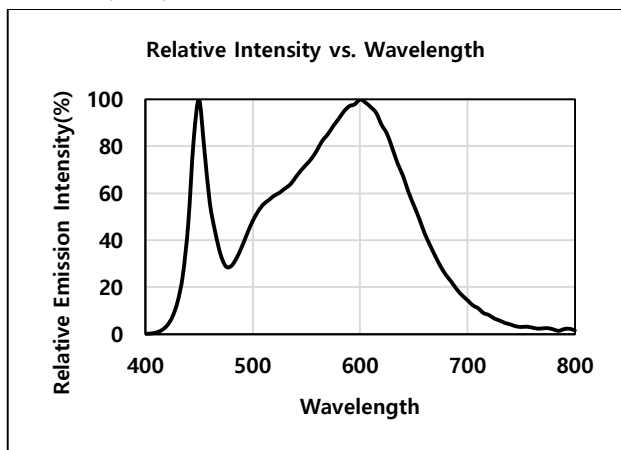

CCT: 4000 K (80 CRI)

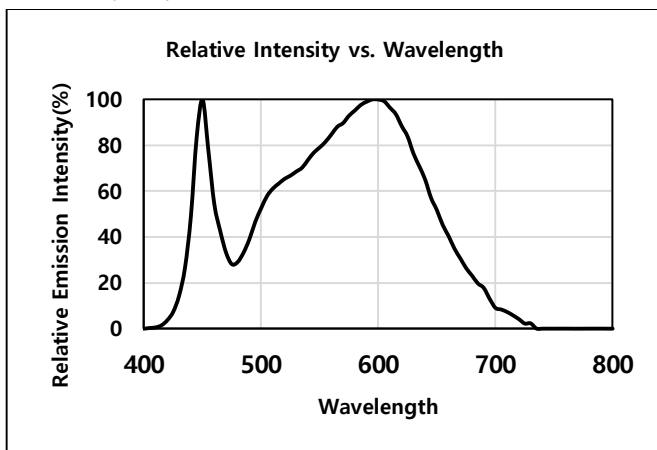

CCT: 5000 K (80 CRI)

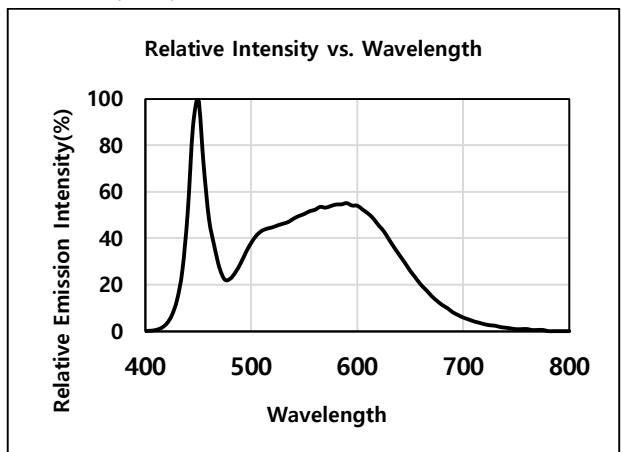

CCT: 5700 K (80 CRI)

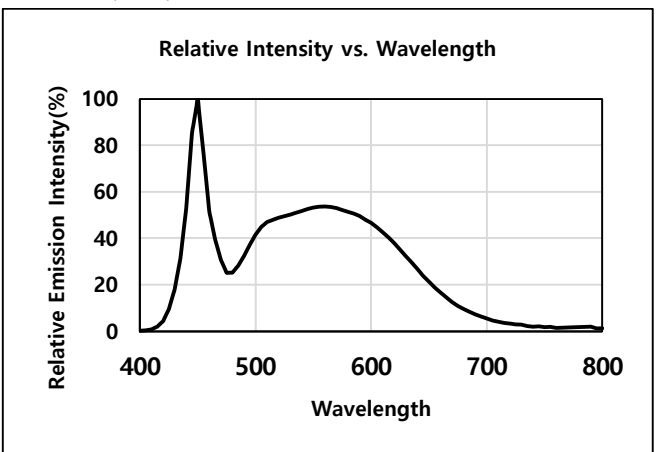

CCT: 6500 K (80 CRI)

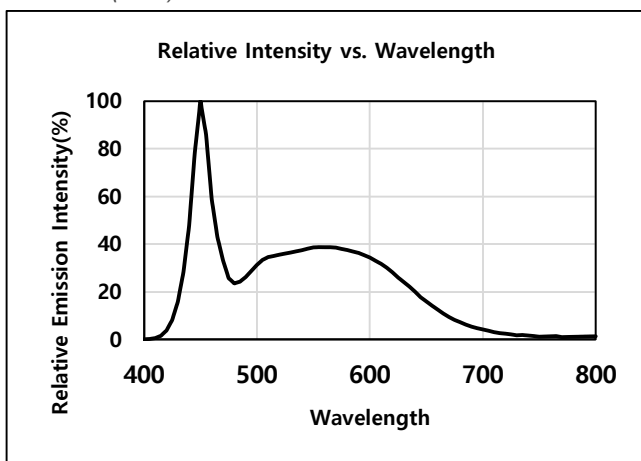
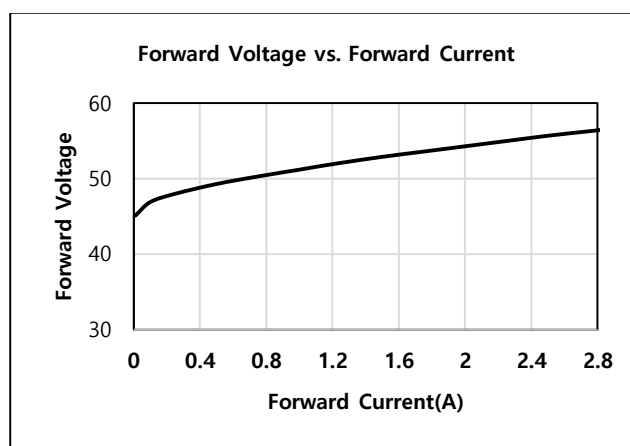
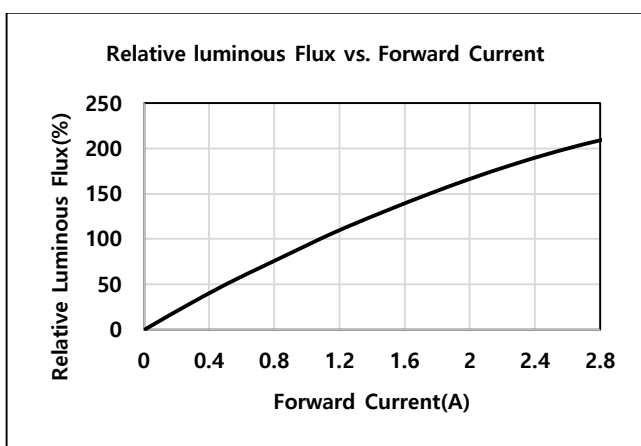
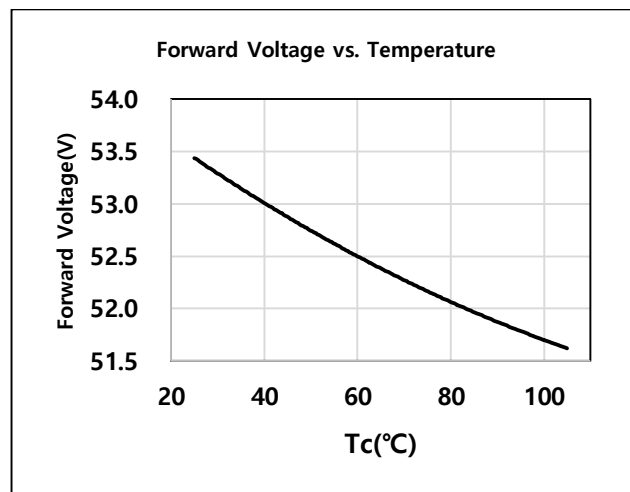
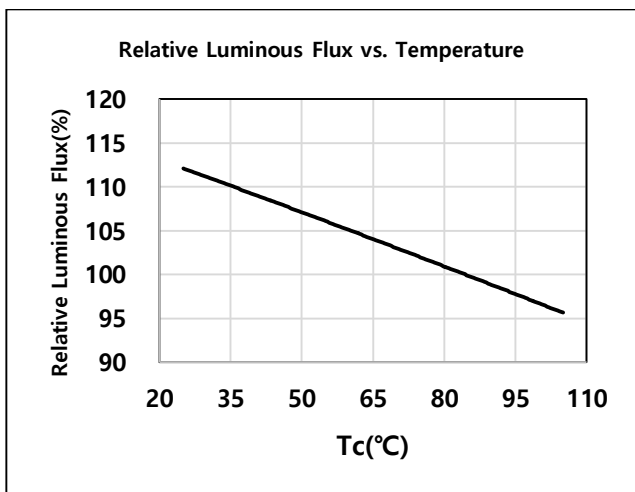
b) Forward Current Characteristics ($T_j = 85^\circ\text{C}$)c) Temperature Characteristics ($I_f = 1080\text{mA}$)

d) Color Shift Characteristics ($T_J = 25\text{ }^\circ\text{C}$, $I_F = 1080\text{mA}$, CRI80+)

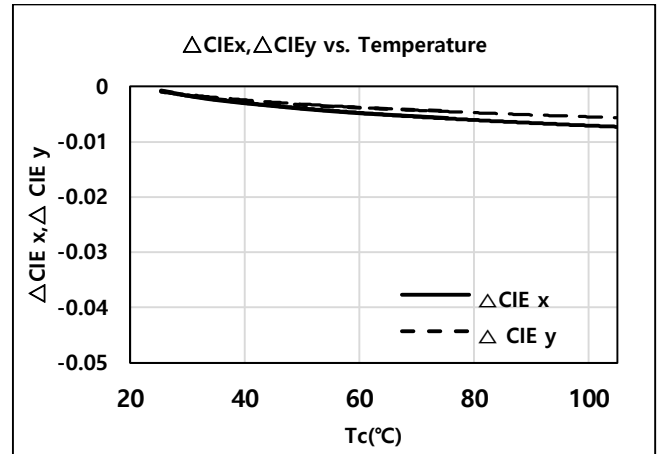
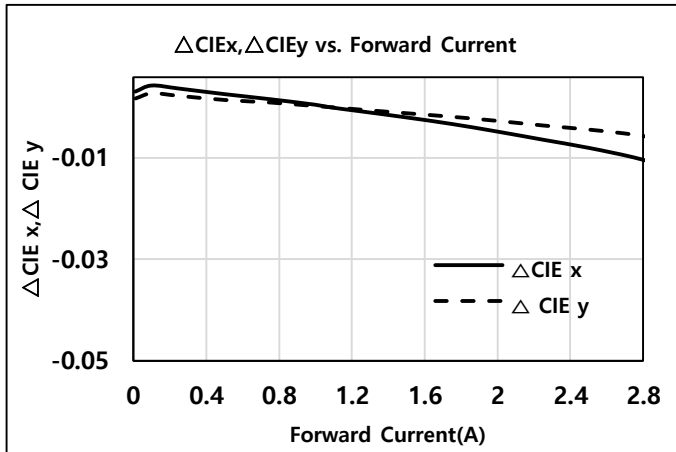

e) Beam Angle Characteristics ($I_F = 1080\text{ mA}$, $T_J = 85\text{ }^\circ\text{C}$)

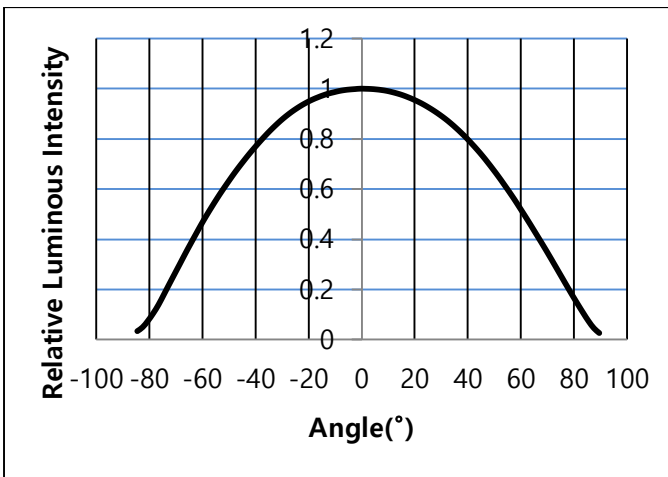

f) Derating Characteristics

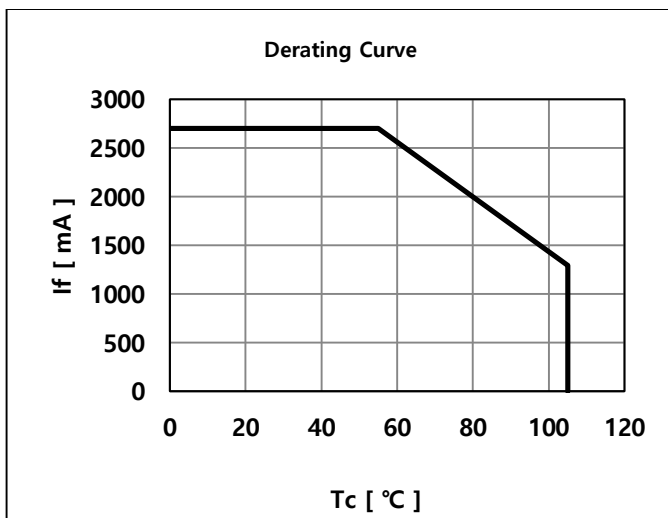

4. Outline Drawing & Dimension

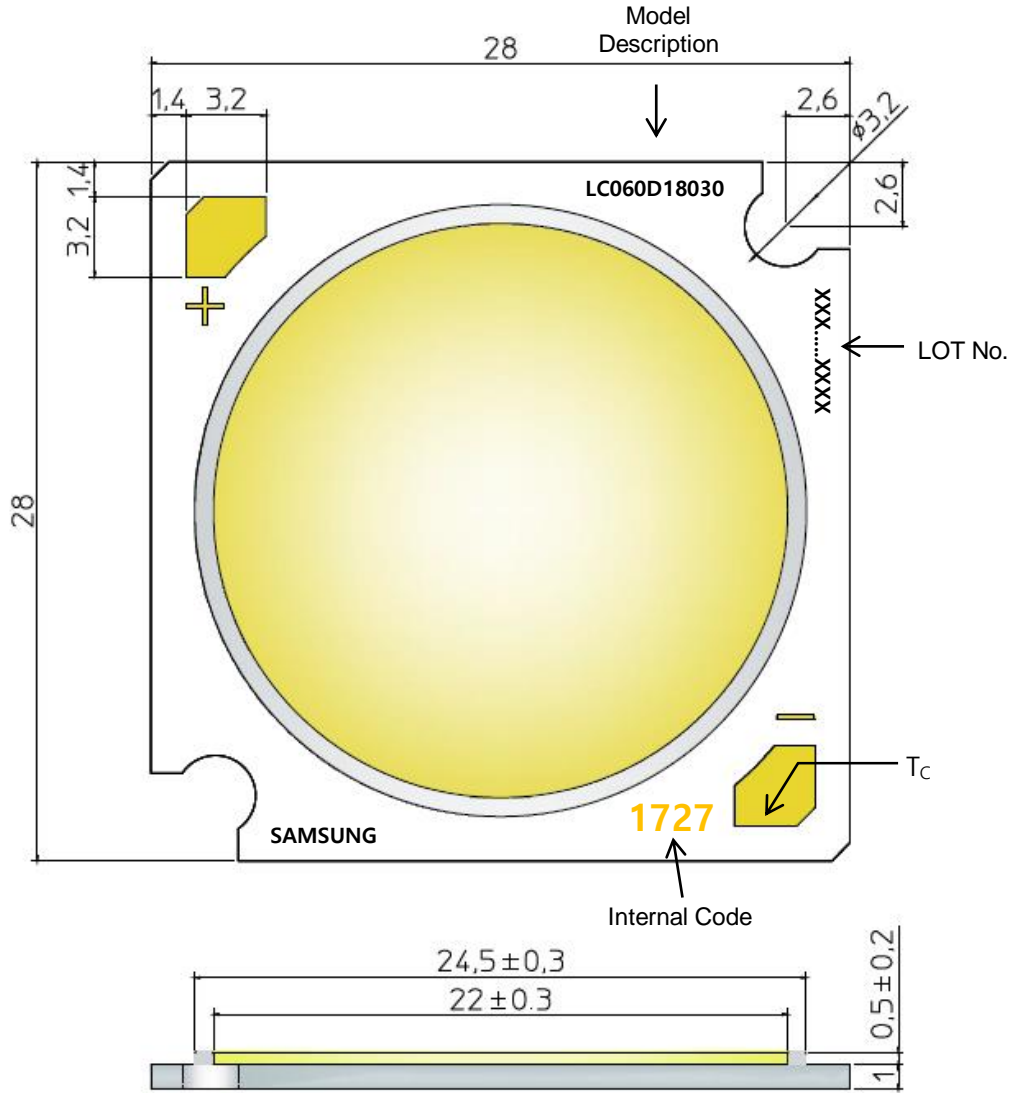

- 1. Unit: mm
- 2. Tolerance: ± 0.3 mm

Item	Dimension	Tolerance	Unit
Length	28.0	±0.15	mm
Width	28.0	±0.15	mm
Height	1.50	±0.20	mm
Light Emitting Surface (LES) Diameter	22.0	±0.30	mm

Note: Denoted product information above is only an example
 (LC060D18030 : LC060D, CRI80+, 3000K)

5. Reliability Test Items & Conditions

a) Test Items

Test Item	Test Condition	Test Hour / Cycle
High Temperature Humidity Life Test	60 °C, 90 % RH,, DC Derating, I _F	1000 h
High Temperature Life Test	85 °C, DC Derating, I _F	1000 h
Low Temperature Life Test	-40 °C, DC , I _F = 1944 mA	1000 h
Pulsed Operating Life Test	55 °C, Pulse width 100 μs, duty cycle 3 %	1000 h
High Temperature Storage	120 °C	1000 h
Low Temperature Storage	-40 °C	1000 h
Temperature Humidity Storage	60 °C, 90% RH	1000h
Thermal Cycle	-45 °C / 15 min ↔ 125 °C / 15 min temperature change in 5 min	500 cycles
Temperature Cycle On/Off Test	-40 °C / 85 °C each 20 min, 30 min transfer power on/off each 5 min, DC Derating, I _F = max	100 cycles
ESD (HBM)	R ₁ : 10 MΩ R ₂ : 1.5 kΩ C: 100 pF V: ±2 kV	5 times
ESD (MM)	R ₁ : 10 MΩ R ₂ : 0 kΩ C: 200 pF V: ±0.2 kV	5 times
Vibration Test	20 ~ 80 Hz (displacement: 0.06 inch, max. 20 g) 80 ~ 2 kHz (max. 20 g) min. frequency ↔ max. frequency 4 min transfer	4 times
Mechanical Shock Test	1500 g, 0.5 ms each of the 6 surfaces (3 axis x 2 sides)	5 times
Sulfur Resistance	25 °C, 75%, H ₂ S 15 ppm	504h

b) Criteria for Judging the Damage

Item	Symbol	Test Condition (T _c = 25 °C)	Limit	
			Min.	Max.
Forward Voltage	V _F	I _F = 1080 mA	L.S.L. * 0.9	U.S.L. * 1.1
Luminous Flux	Φ _v	I _F = 1080 mA	L.S.L. * 0.7	U.S.L. * 1.3

6. Label Structure

a) Label Structure

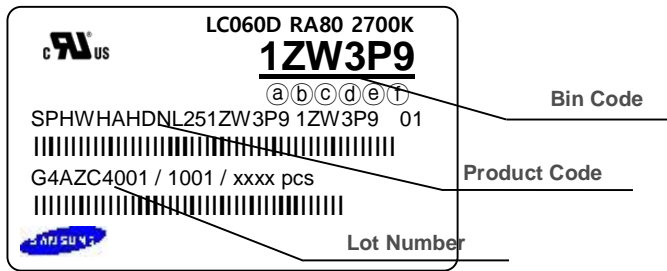

Note: Denoted bin code and product code above is only an example (see description on page 5)

Bin Code:

- ⒶⒷ: Forward Voltage bin (refer to page 11)
- ⒸⒹ: Chromaticity bin (refer to page 9-10)
- ⒺⒻ: Luminous Flux bin (refer to page 6)

b) Lot Number

The lot number is composed of the following characters:

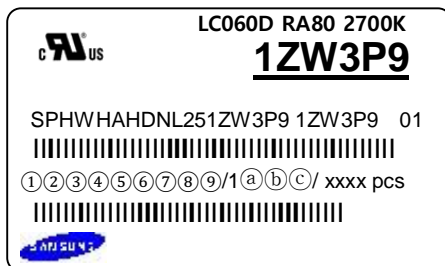

① ③④⑤⑥⑦⑧⑨ / 1ⒶⒷⒸ / xxxx pcs

- ① : Production site (S: Giheung, Korea, G: Tianjin, China)
- ② : 4 (LED)
- ③ : Product state (A: Normal, B: Bulk, C: First Production, R: Reproduction, S: Sample)
- ④ : Year (Z: 2015, A: 2016, B: 2017...)
- ⑤ : Month (1~9, A, B, C)
- ⑥⑦⑧⑨ : Day (1~9, A, B~V)
- ⒶⒷⒸ : Product serial number (001 ~ 999)

6. Packing Structure

Packing material	Max. quantity in pcs of COB	Dimension(mm)			
		Length	Width	Height	Tolerance
Tray	16	160	180	10	1.0
Aluminum Bag	32(2 trays)	210	241		10
Inner Box	128	230	84	260	2
Outer Box	1280	476	445	272	5

a) Packing Structure

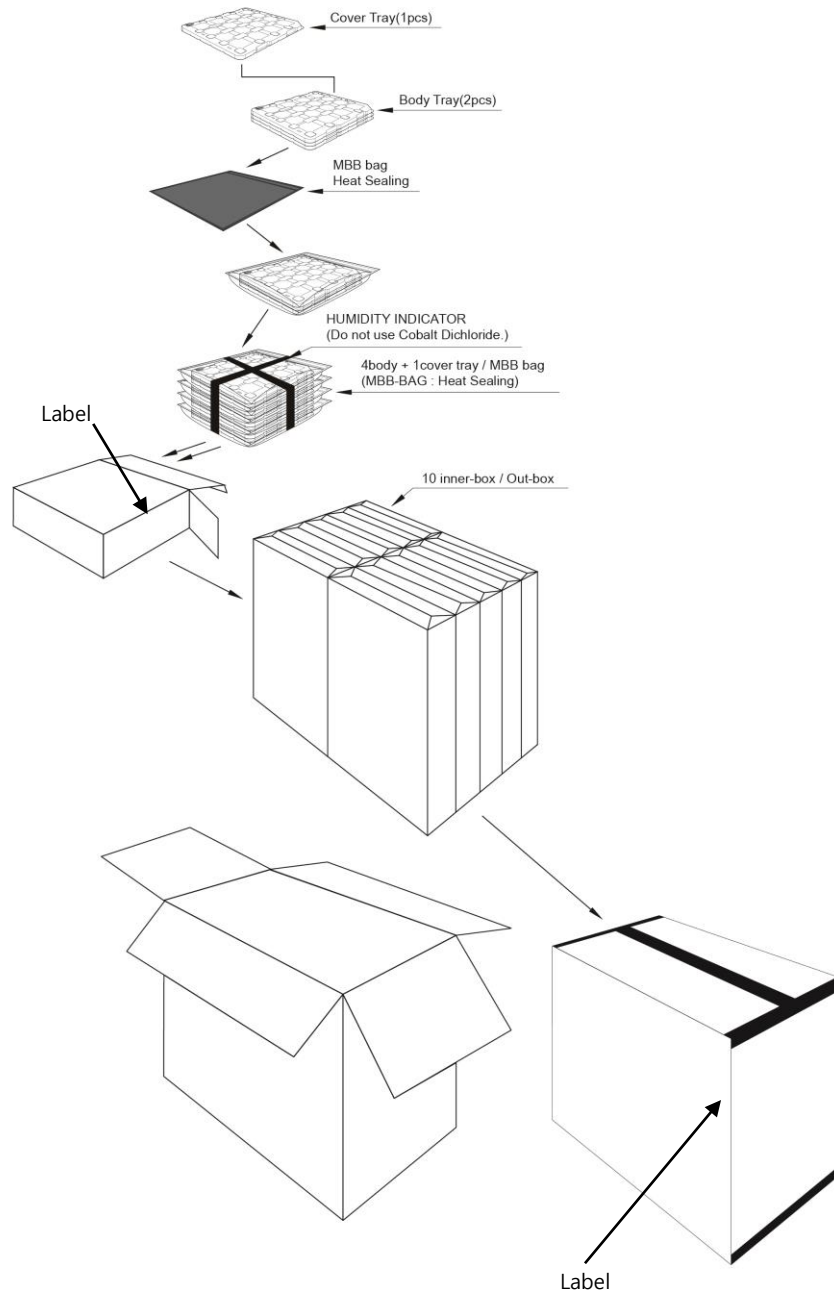

8. Precautions in Handling & Use

- 1) This device should not be used in any type of fluid such as water, oil, organic solvent, etc. When cleaning is required, IPA is recommended as the cleaning agent. Some solvent-based cleaning agent may damage the silicone resins used in the device.
- 2) LEDs must be stored in a clean environment. If the LEDs are to be stored for three months or more after being shipped from Samsung, they should be packed with a nitrogen-filled container (shelf life of sealed bags is 12 months at temperature 0~40 °C, 0~90 % RH).
- 3) After storage bag is opened, device subjected to soldering, solder reflow, or other high temperature processes must be:
 - a. Mounted within 672 hours (28 days) at an assembly line with a condition of no more than 30 °C / 60 % RH, or
 - b. Stored at <10 % RH
- 4) Repack unused products with anti-moisture packing, fold to close any opening and then store in a dry place.
- 5) Devices require baking before mounting, if humidity card reading is >60 % at 23 ± 5 °C.
- 6) Devices must be baked for 1 hour at 60 ± 5 °C, if baking is required.
- 7) The LEDs are sensitive to the static electricity and surge current. It is recommended to use a wrist band or anti-electrostatic glove when handling the LEDs. If voltage exceeding the absolute maximum rating is applied to LEDs, it may cause damage or even destruction to LED devices. Damaged LEDs may show some unusual characteristics such as increase in leakage current, lowered turn-on voltage, or abnormal lighting of LEDs at low current.
- 8) The thermal management is one of the most critical factors for the LED lighting system. Especially the LED junction temperature should not exceed the absolute maximum rating while operation of LED lighting system.
For more information, please refer to Application Note 'Mechanical & Thermal Guide for COB'.
- 9) In case of driving LEDs around the minimum current level (I_{f_min}), chips might exhibit different brightness due to the variation in I-V characteristics of each one. This is normal and does not adversely affect the performance of product.
- 10) VOCs (Volatile Organic Compounds) can be generated from adhesives, flux, hardener or organic additives used in luminaires (fixtures). Transparent LED silicone encapsulant is permeable to those chemicals and they may lead to a discoloration of encapsulant when they exposed to heat or light. This phenomenon can cause a significant loss of light emitted (output) from the luminaires. In order to prevent these problems, we recommend users to know the physical properties of materials used in luminaires and they must be carefully selected.
- 11) The resin area is very sensitive, please do not handle, press, touch, rub, clean, or pick by with tweezers on it. Instead, please pick at the handling area as indicated below.

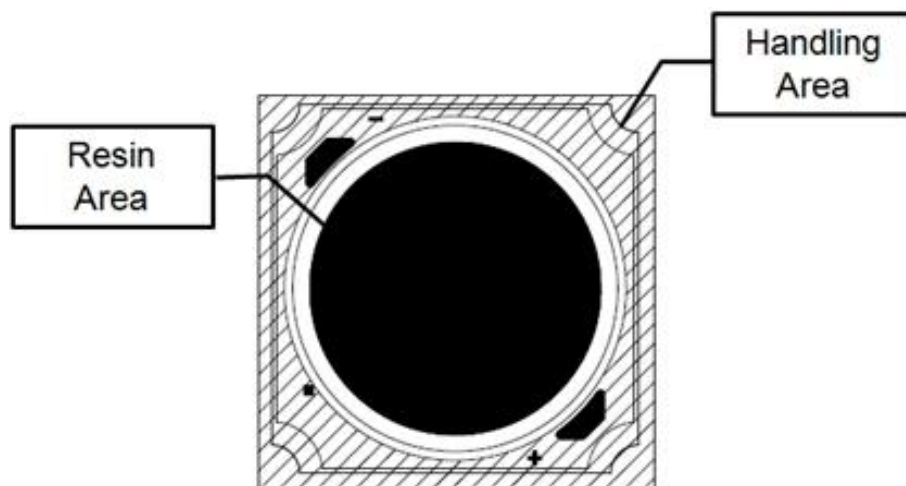

Legal and additional information.

About Samsung Electronics Co., Ltd.

Samsung Electronics Co., Ltd. inspires the world and shapes the future with transformative ideas and technologies, redefining the worlds of TVs, smartphones, wearable devices, tablets, cameras, digital appliances, printers, medical equipment, network systems and semiconductors. We are also leading in the Internet of Things space through, among others, our Digital Health and Smart Home initiatives. We employ 307,000 people across 84 countries. To discover more, please visit our official website at www.samsung.com and our official blog at global.samsungtomorrow.com.

Copyright © 2015 Samsung Electronics Co., Ltd. All rights reserved.
Samsung is a registered trademark of Samsung Electronics Co., Ltd.
Specifications and designs are subject to change without notice. Non-metric weights and measurements are approximate. All data were deemed correct at time of creation. Samsung is not liable for errors or omissions. All brand, product, service names and logos are trademarks and/or registered trademarks of their respective owners and are hereby recognized and acknowledged.

Samsung Electronics Co., Ltd.
95, Samsung 2-ro
Giheung-gu
Yongin-si, Gyeonggi-do, 446-711
KOREA

www.samsungled.com

